

MODEL 211.0/ 2

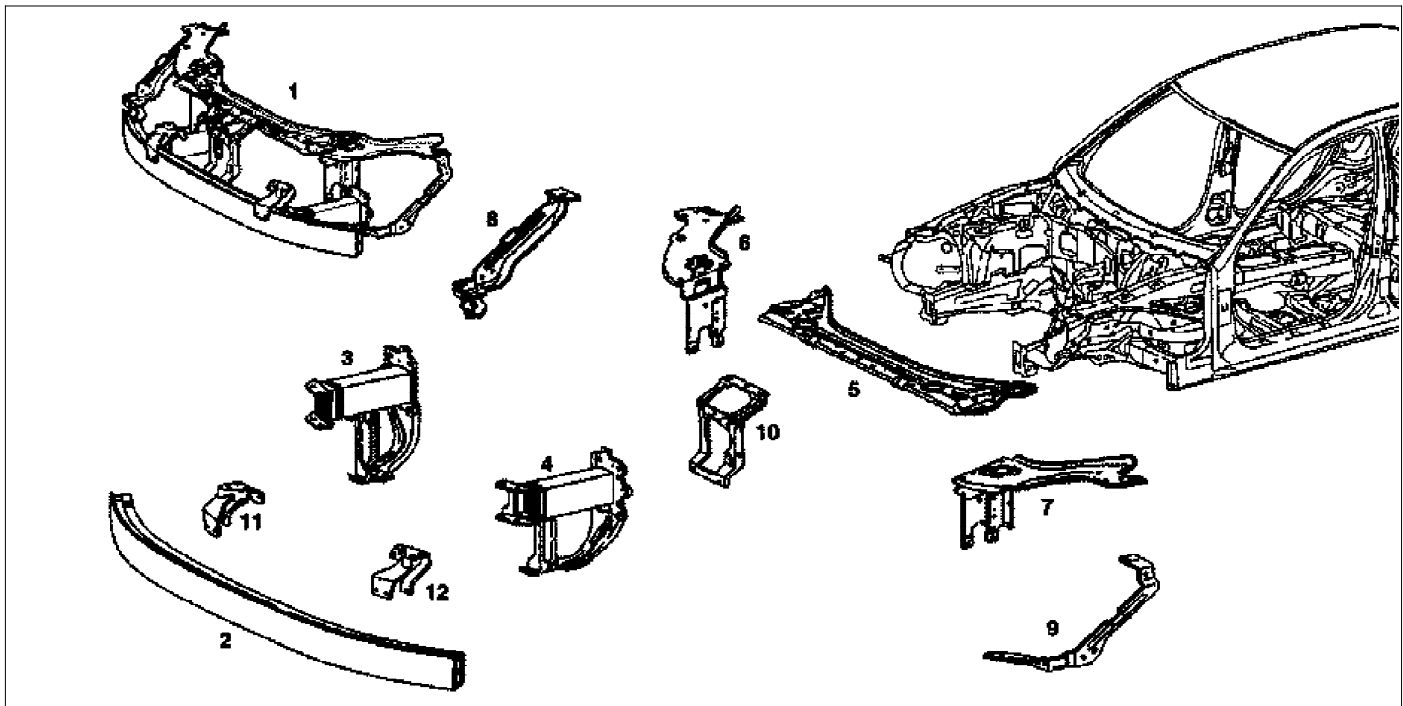

P62.30-2088-09

- 1 Complete front end assembly  
 2 Front crossmember  
 3 Right crash box absorber  
 4 Left crash box absorber

- 5 Front center reinforcement  
 6 Right reinforcement  
 7 Left reinforcement  
 8 Right frame

- 9 Left frame  
 10 Catch hook reinforcement  
 11 Combination bracket for right console  
 12 Combination bracket for left console

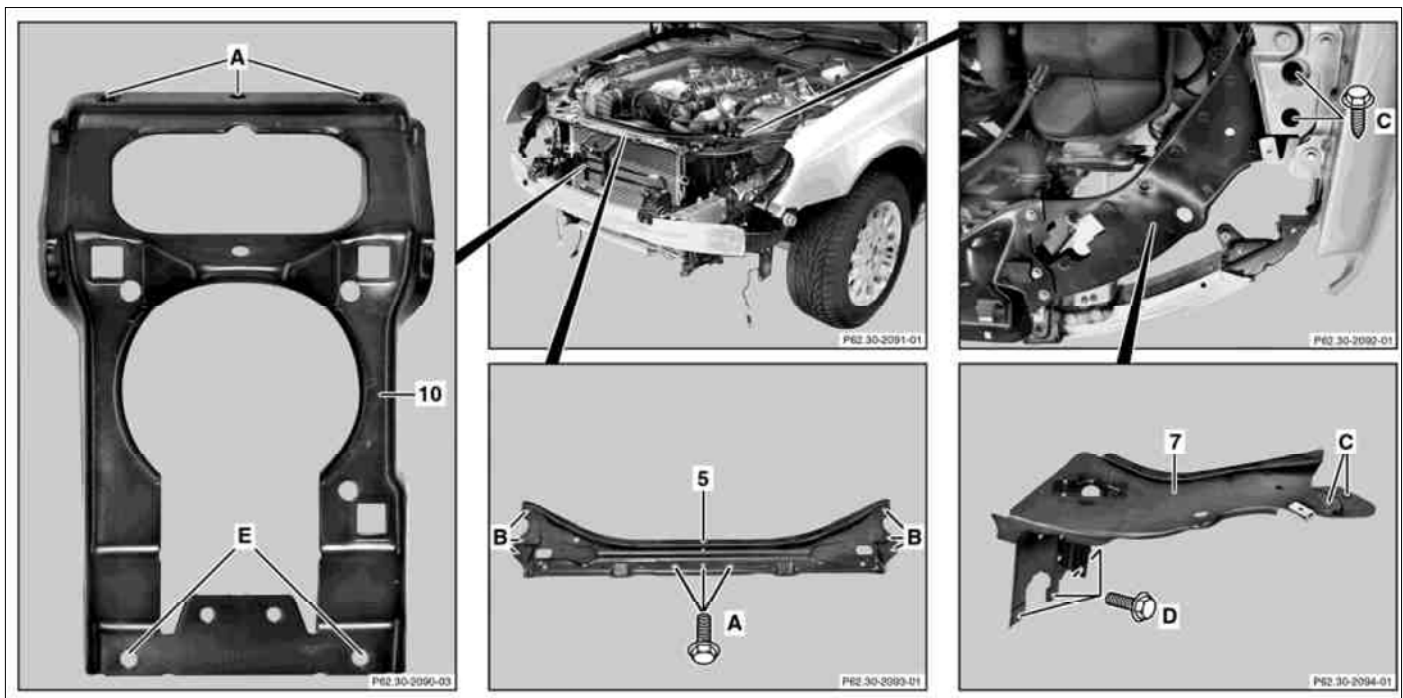

P62.30-2089-09

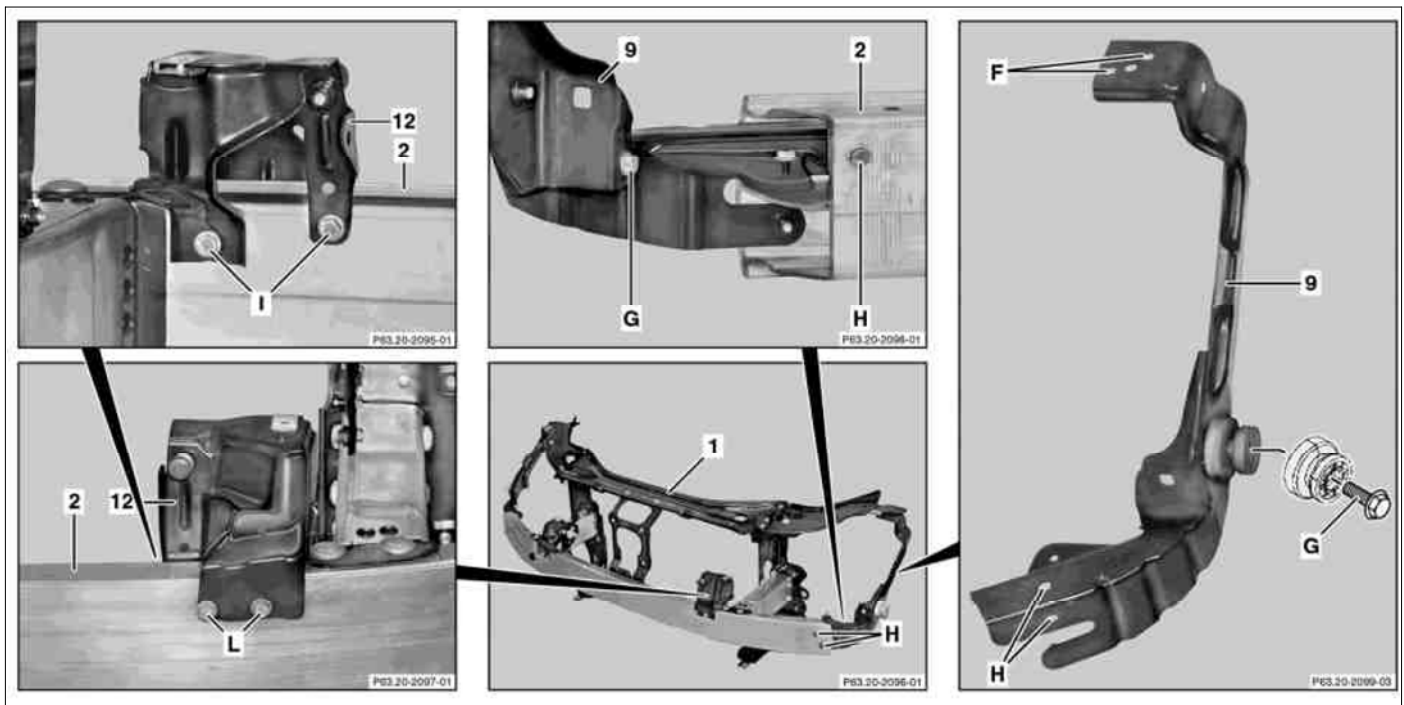

P62.30-2100-09

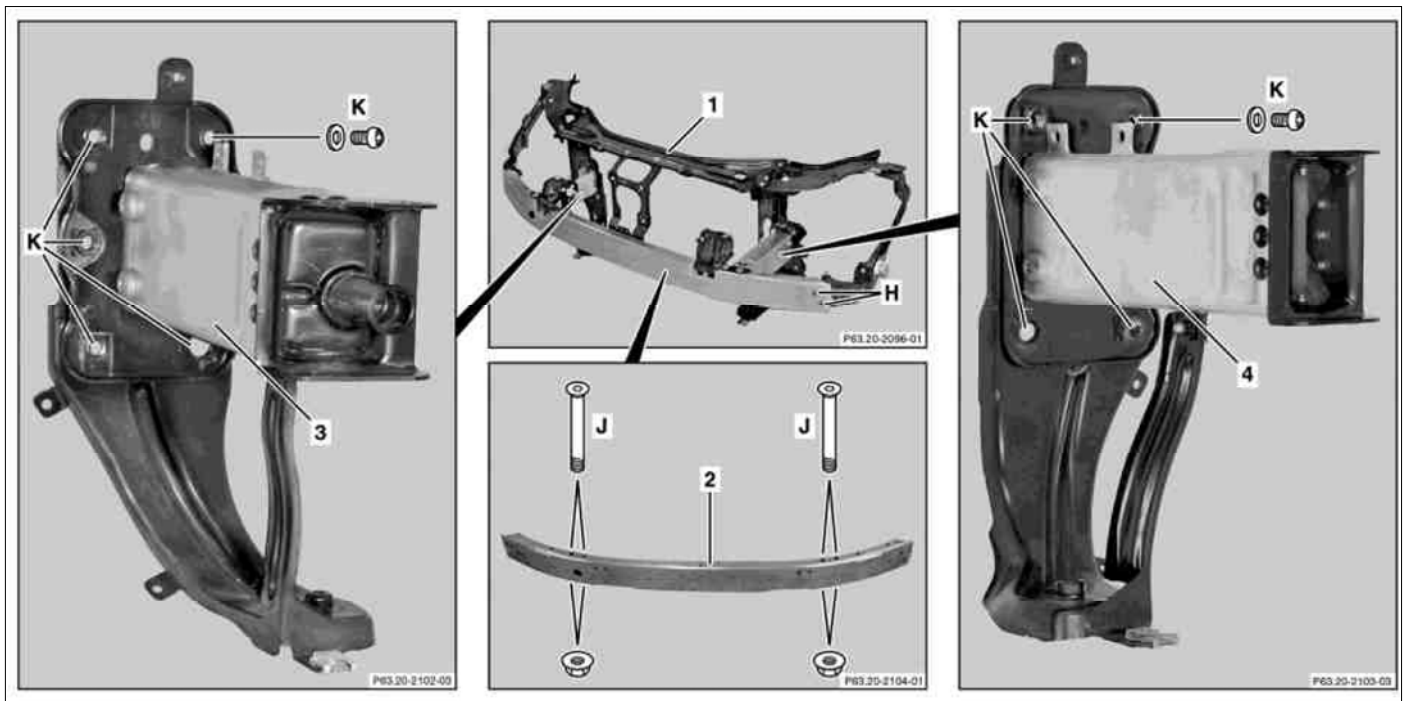













P62.30-2101-09

**Modification notes**

30.6.04	Value modified from 70 Nm to 55 Nm	Value modified in BA62.30-P-1001-02A for model 211	*BA62.30-P-1001-02A
---------	------------------------------------	--	---------------------

	Remove		
1	Remove lamp unit		AR82.10-P-4730T
2	Remove detachable parts in area to be repaired		
3	Unscrew screws (A and B) and remove reinforcement at front center (5)		
4	Unscrew screws (C)		
5	Fasten radiator with fastening belt		
6	Unscrew screws (K)		
7	Remove front end (1)		
	Install		
8	Install right (3) and left (4) crash box absorber to longitudinal member(screws K)	Position screws loosely.	

9	Center right (8) and left (9) frame on crossmember (2) and screw on (screws H)		
10	Screw crossmember (2) to right (3) and left (4) crash box absorber (screws J)		
11	Center right (3) and left (4) crash box absorber on longitudinal member and tighten bolts (K).		
12	Install right (6) and left (7) reinforcement, center and screw on (screws D and C)		
13	Screw right (6) and left (7) reinforcement to fender bracket (screws C)		
14	Install center reinforcement (5), center and screw on (screws B)		
15	Install catch hook reinforcement (10), center and screw on (screws A and E)		
16	Install right combination bracket console (11) and left combination bracket console (12), center and screw on (bolts L and I).		
17	Adjust front module	<p> Fit headlamp unit and bumper for adjustment work.</p> <p> Screw, front end to longitudinal member</p> <p> Screw, outer reinforcement to fender bracket</p> <p> Screw, outer reinforcement to side frame</p> <p> Screw, center reinforcement to outer reinforcement</p> <p> Screw, center reinforcement to catch hook reinforcement</p> <p> Screw, catch hook reinforcement to crossmember</p> <p> Bolt, crossmember to crash box</p> <p> Screw, crossmember to combination bracket console</p> <p> Bolt, side frame to crossmember</p> <p> Screw, outer reinforcement to crash box</p>	<p>AR62.30-P-1570-01T</p> <p>*BA62.30-P-1001-02A</p> <p>*BA62.30-P-1006-02A</p> <p>*BA62.30-P-1007-02A</p> <p>*BA62.30-P-1008-02A</p> <p>*BA62.30-P-1009-02A</p> <p>*BA62.30-P-1010-02A</p> <p>*BA62.30-P-1011-02A</p> <p>*BA62.30-P-1012-02A</p> <p>*BA62.30-P-1013-02A</p> <p>*BA62.30-P-1014-02A</p>
18	Adjust gap dimensions on hoods, doors and lids	<p>Gap dimensions</p> <p> Feeler gauge</p>	<p>*BE60.00-P-1001-01F</p> <p>*129589032100</p>
19	Install detachable body components in area to be repaired		
20	Install lamp unit		AR82.10-P-4730T

#### Test values for gap dimensions on hoods, doors and lids

Number	Designation	Model 211.0	Model 211.2
BE60.00-P-1001-01F	Gap dimension Engine hood to fender	Dimension "A" mm	3.5 (F0.5)
	Engine hood to headlamp	Dimension "B" mm	4 (+1)
	Radiator grille to bumper	Dimension "C" mm	5.5 (+1)
	See figure in	AR60.00-P-0700-01T	AR60.00-P-0700-01TA

#### Front end assembly with front reinforcement

Number	Designation	Model 211
BA62.30-P-1001-02A	Bolt, front end to longitudinal member	Nm 55
BA62.30-P-1006-02A	Bolt, outer reinforcement to fender bracket	Nm 10
BA62.30-P-1007-02A	Bolt, outer reinforcement to side of frame	Nm 10
BA62.30-P-1008-02A	Bolt, center reinforcement to outer reinforcement	Nm 10

BA62.30-P-1009-02A	Bolt, center reinforcement to arrester hook reinforcement	Nm	10
BA62.30-P-1010-02A	Bolt, arrester hook reinforcement to crossmember	Nm	10
BA62.30-P-1011-02A	Bolt, crossmember to crash box	Nm	18
BA62.30-P-1012-02A	Bolt, crossmember to combination bracket console	Nm	10
BA62.30-P-1013-02A	Bolt, side of frame to crossmember	Nm	10
BA62.30-P-1014-02A	Bolt, outer reinforcement to crash box	Nm	10

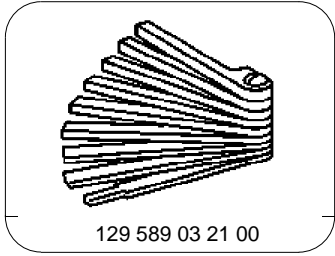

Feeler gauge