

N73

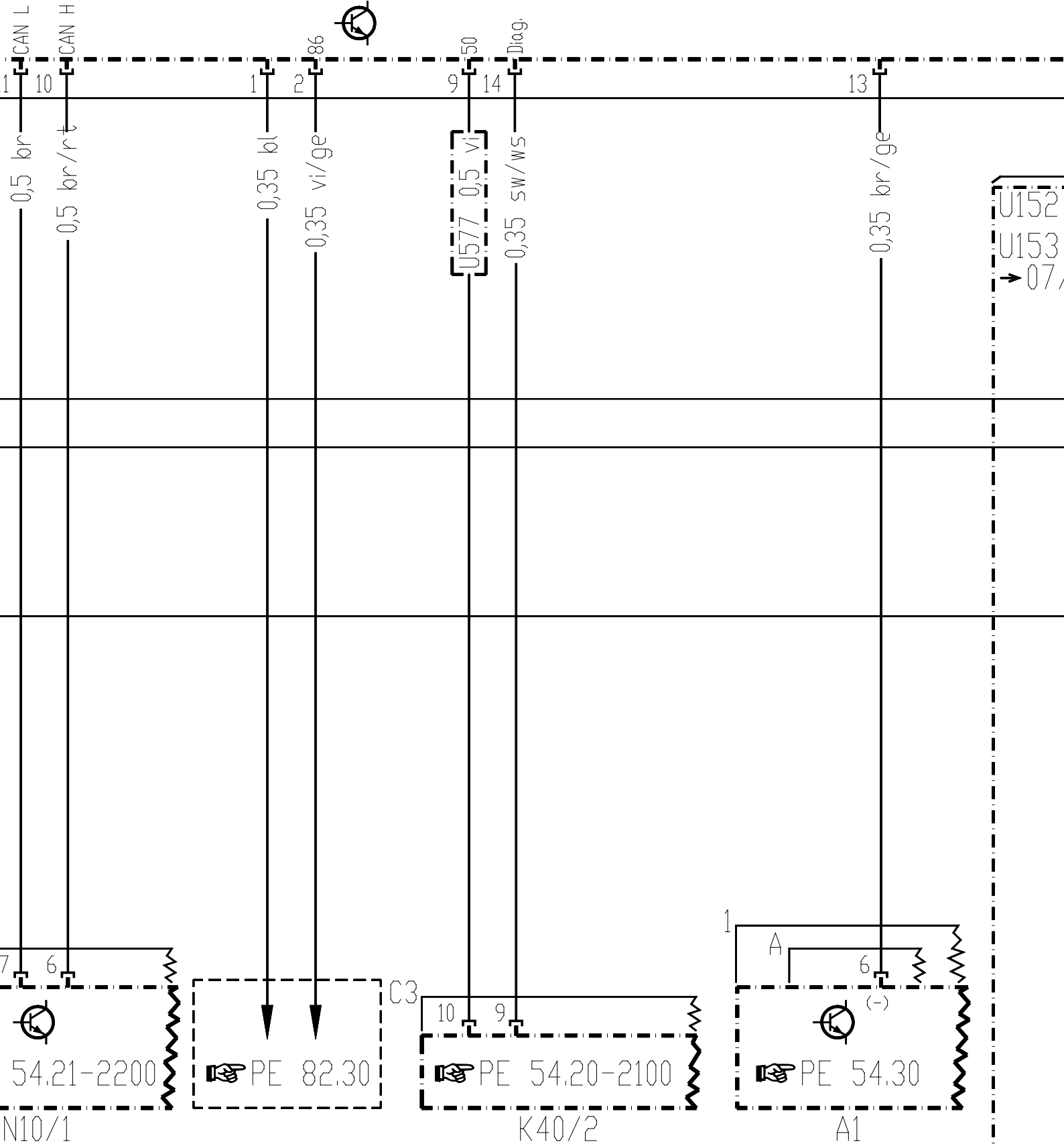

N10/1

K40/2

A1

N73



8

U153
08/99 →

/99

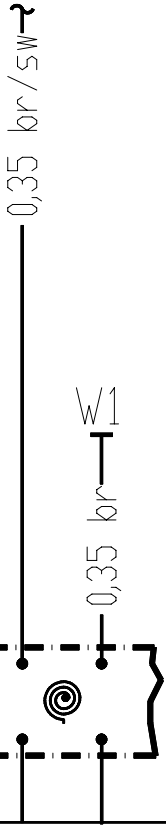

0,35 br/sw

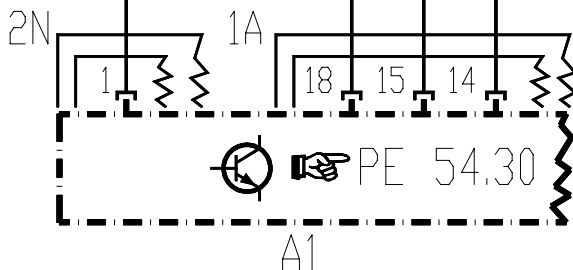
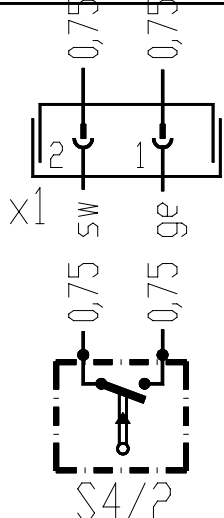
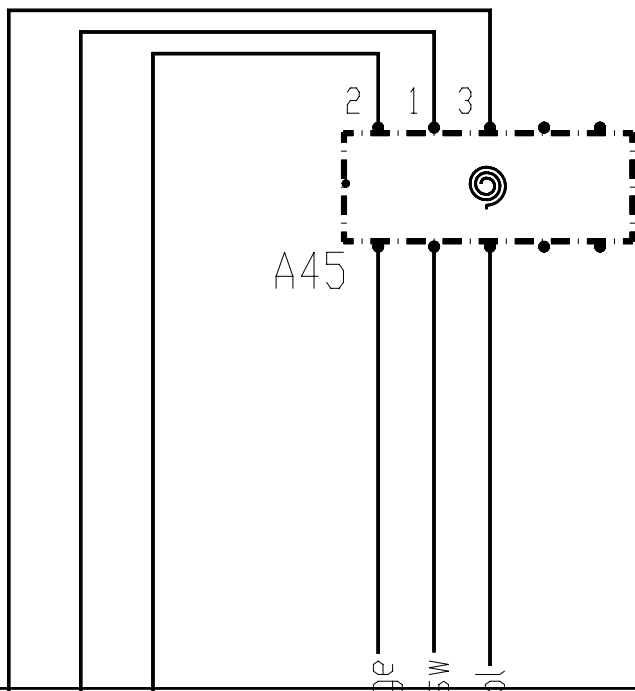

A45x2

0,5 kl

0,5 sw

0,5 ge

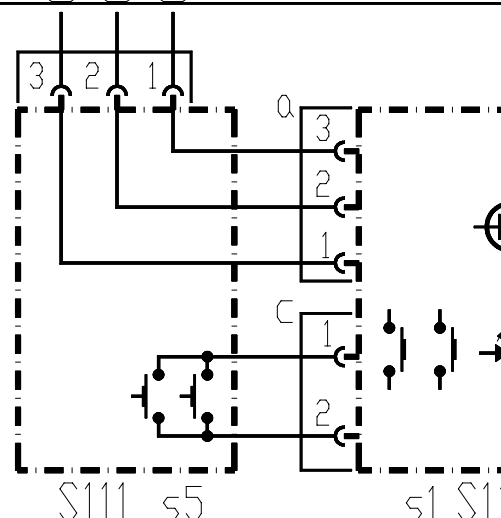

N73

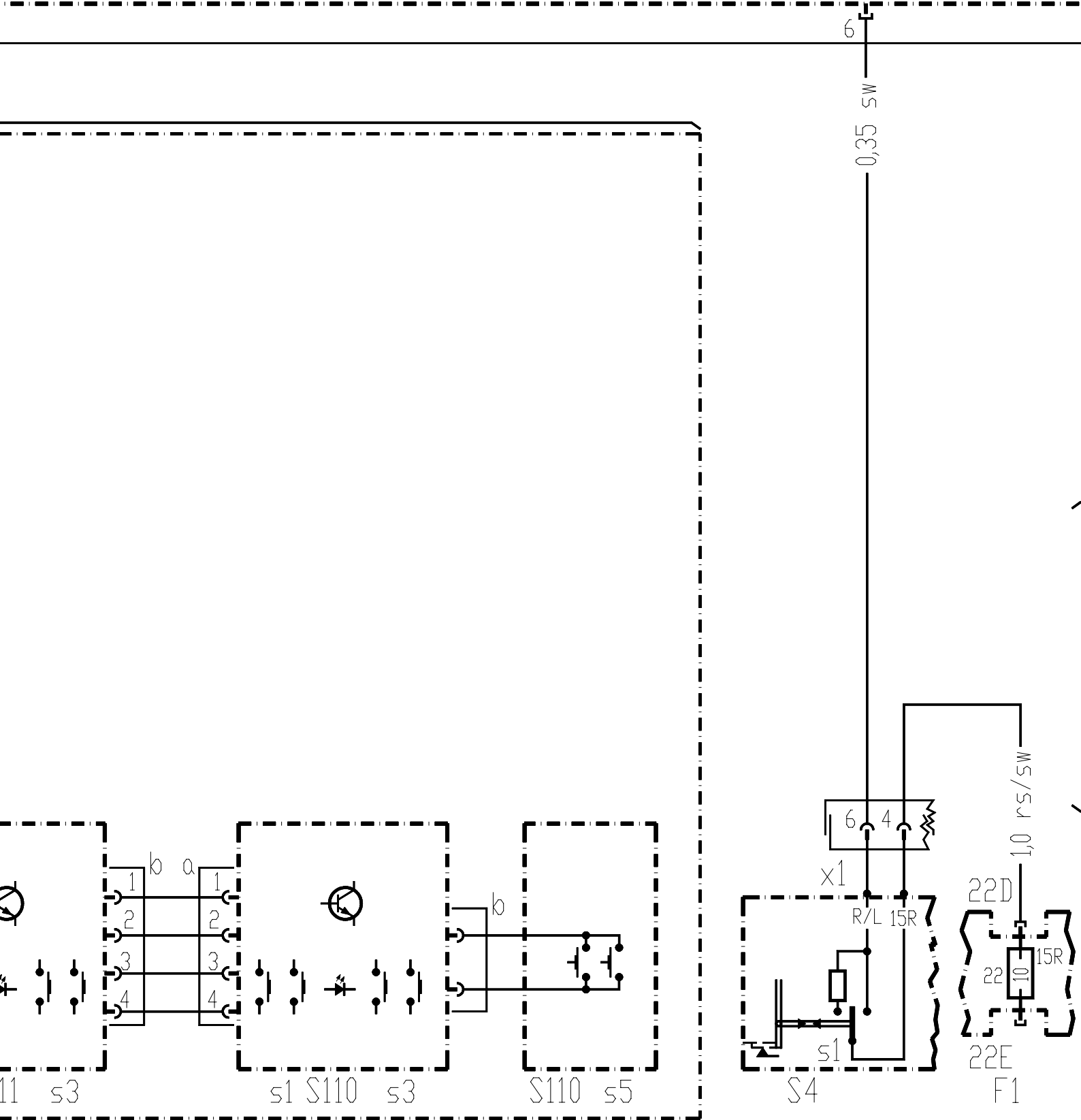

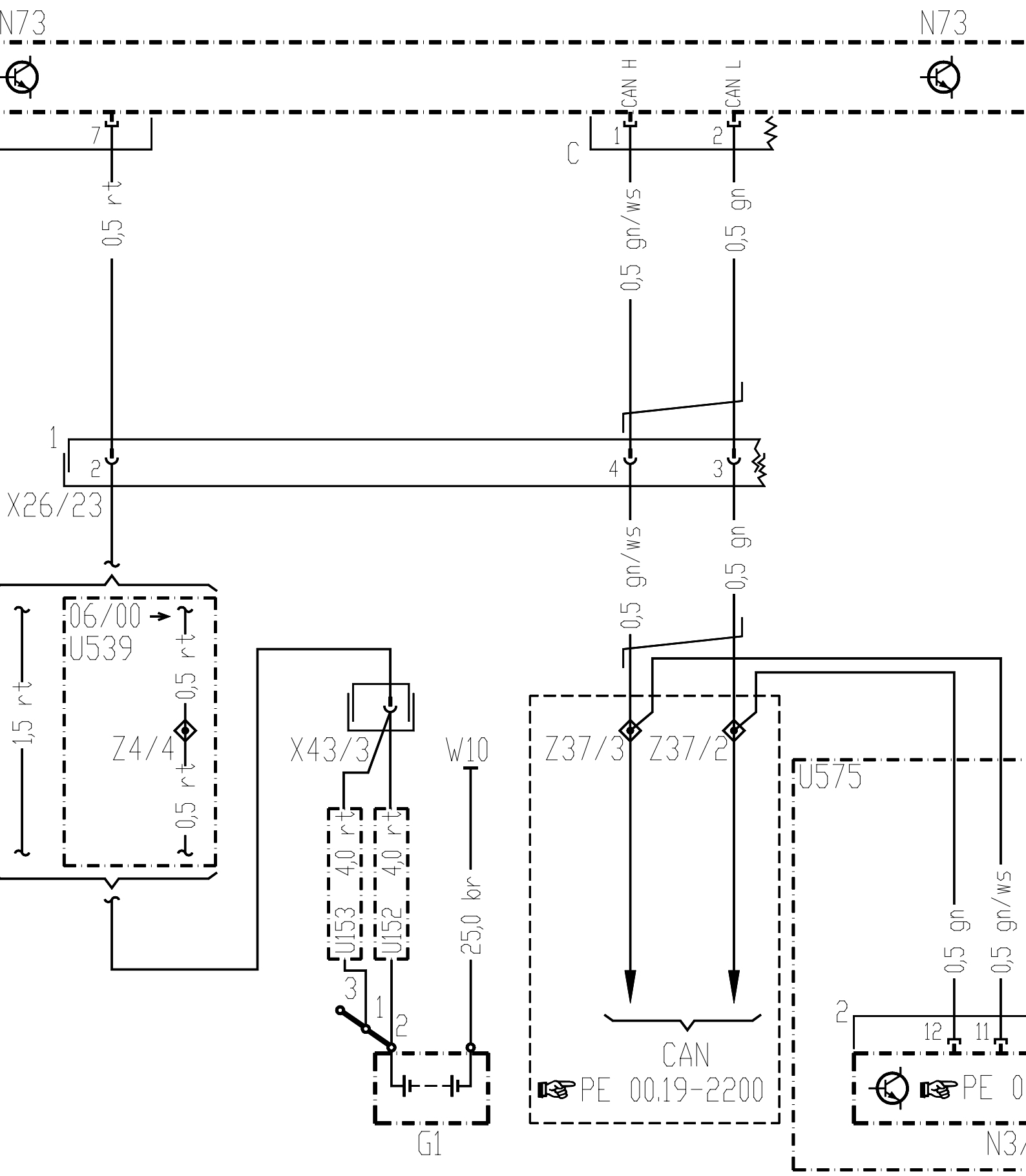

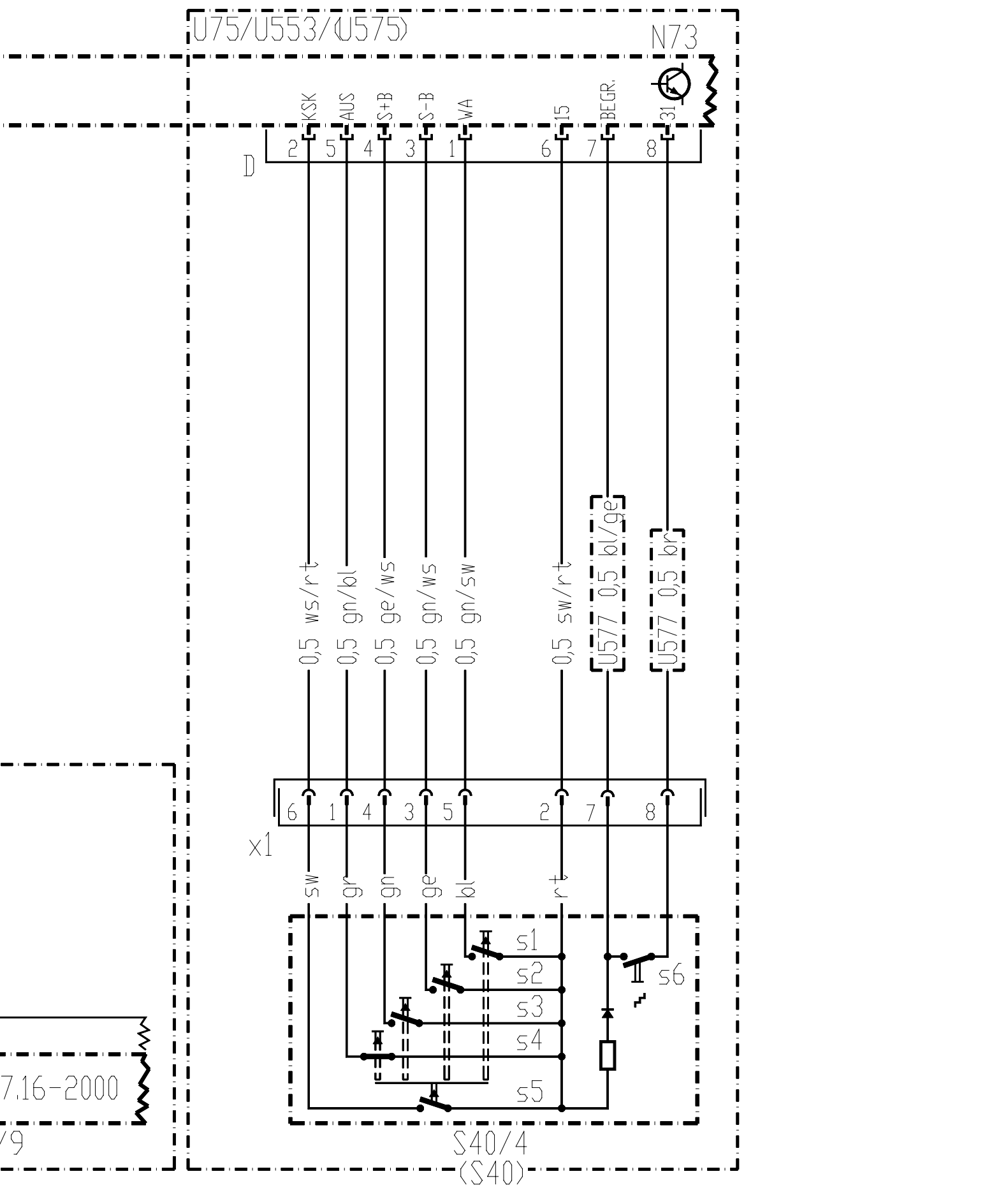

54

55

56

A

B

C

D

E

F

G

H

J

K

L

PE 80.57-P-2100-99A

54

55

56

